

LENTE TRACK RT8



Track mounted, adjustable spotlight with premium class UGR<19 lens optics. Top quality SMD LED module with colour consistency MacAdams ≤ 3 , extensive portfolio of lumen ranges, CCTs and spectra. Variety of track adaptor integrated drivers: standard EVG on/off, DALI and wireless controlled as MasterConnect or Casambi on request. Remote, wireless occupancy & daylight sensor available to allow significant energy savings and wireless connectivity. Mounting on universal track systems: Global / Unipro. Track adaptor for any other type of track system on request. Body is made of aluminium and steel. Standard colour RAL 9005S, any other colour from basic RAL range available at no extra cost. Variety of optics, lumen outputs and drivers allows to use this luminaire in different types of lighting projects. Luminous flux & Luminaire Power tolerance up to 10%. System power consumption depends on components used. Luminous efficacy depends on type of LED's, electronics, optics and diffusor. The most up to date technical parameters can be found on our website and in database of LDT files.

Lighting direction



PDF datasheet:



LENTE TRACK RT8

Mounting:	Track mounted
Body material:	Steel and aluminium
Colour:	Standard black RAL 9005S, other RAL colours on request
Lumen output:	Standard up to 6000 lm, any other on request
LED module:	Signify (Philips), Tridonic or equivalent SMD LED modules
Colour temperature:	3000/4000K other on request
Colour Rendering:	CRI>80 in standard, other on request
Driver:	EVG on-off/DALI/MC (MasterConnect), other on request
Wireless control:	Philips MasterConnect / Casambi, other on request
Daylight/Occupancy sensor:	Wireless MCS sensor
Emergency unit:	N/A
Operating temperature range:	0°C ... +35°C
IP Class:	IP20 in standard
Power:	220-240V 50/60Hz
Lighting direction:	Direct lighting
Light distribution:	Symmetric
Optics:	UGR<19 diffused lenses
Lens shade:	BM - black matt, WM - white matt
Beam angle:	50°/80° - all types available in our LDT file database
Warranty:	5 Years standard warranty

LENTE TRACK RT8 track mounted luminaire

All current index numbers, lumen outputs, power consumption and many other technical information are available in our 2024 pricelist. Details on wireless lighting control systems on page number 896.



Energy saving MasterConnect wireless lighting control system with daylight and movement detection technology on request.



BM lens shade



WM lens shade



MCS wireless daylight&occ sensor



XCS wireless switch

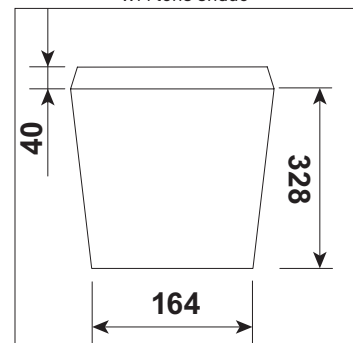

Basic dimensions